

7 DEALER MANUAL FOR DP C220.CAN



CONTENT

7.1 Important Notice	2	7.7.2 Selection of Support Levels.....	6
7.2 Introduction of Display	2	7.7.3 Selection mode.....	6
7.3 Product Description	3	7.7.4 Headlights / backlighting.....	7
7.3.1 Specifications.....	3	7.7.5 Walk Assistance.....	7
7.3.2 Functions Overview.....	3	7.7.6 SERVICE.....	8
7.4 Display Installation	4	7.7.7 Battery capacity indication.....	8
7.5 Display	5	7.8 Settings	9
7.6 Key Definition	5	7.8.1 "Display Setting".....	9
7.7 Normal Operation	6	7.8.2 "Information".....	11
7.7.1 Switching the System ON/OFF.....	6	7.9 Error Code Definition	15

7.1 IMPORTANT NOTICE

- If the error information from the display cannot be corrected according to the instructions, please contact your retailer.
- The product is designed to be waterproof. It is highly recommended to avoid submerging the display under water.
- Do not clean the display with a steam jet, high-pressure cleaner or water hose.
- Please use this product with care.
- Do not use thinners or other solvents to clean the display. Such substances can damage the surfaces.
- Warranty is not included due to wear and normal use and aging.

7.2 INTRODUCTION OF DISPLAY

- Model: DP C220.CAN BUS
- The housing material is ABS and Acrylic.
- The label marking is as follows:



-  **Note:** Please keep the QR code label attached to the display cable. The information from the Label is used for a later possible software update.

7.3 PRODUCT DESCRIPTION

7.3.1 Specifications

- Operating temperature: -20 °C~45 °C
- Storage temperature: -20 °C~50 °C
- Waterproof: IPX5
- Storage room Humidity: 30%-70% RH

7.3.2 Functional Overview

- Speed display (including top speed and average speed, switching between km and miles)
- Battery capacity indicator
- Lighting control
- Brightness setting for backlight
- Walk assistance
- Indication of performance support
- Motor output power indicator
- Time display for single journeys
- Kilometer stand (including single-trip distance, total distance and remaining distance)
- Setting the support levels
- Energy consumption indicator CALORIES (Note: If the display has this function)
- Display for the remaining distance (Depends on your riding style)
- Information View (battery, controller, HMI and sensor)
- Error messages view

7.4 DISPLAY INSTALLATION

1. Remove the holding bracket from the display, and then place the display into position on the handlebar. (suitable for \varnothing 22.2mm handlebar).

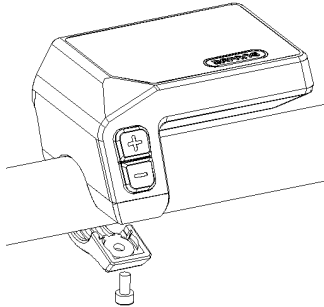

2. Then place the holding bracket on the underside of the display and tighten it into position with a M3.0*8 screw. Torque requirement: 1.0 N.m.

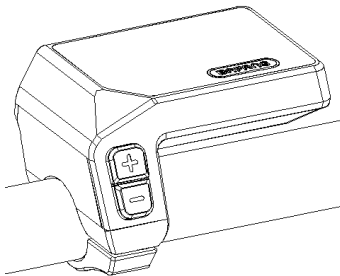

3. Now connect the Display connector to the EB-Bus connector, ensuring both connectors are kept parallel when pushing firmly together.

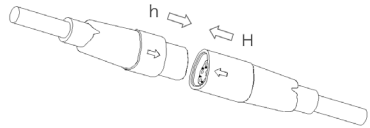

7.5 DISPLAY

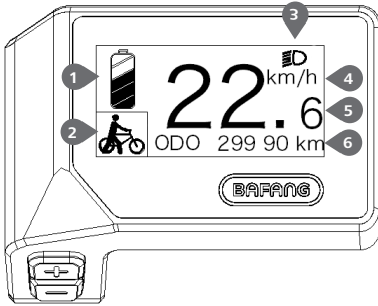

- 1 Display of battery capacity in real time.
- 2 Indicator of support level/walk assistance.
- 3 The display shows this symbol , When the lights are turned on.
- 4 Unit of speed
- 5 Digital speed display
- 6 Trip: Daily kilometers (TRIP) - Total kilometers (ODO) - Top speed (MAX) - Average speed (AVG) - Remaining distance (RANGE) - Energy Consumption (CALORIES) - Output power (POWER)- Travel time (TIME).

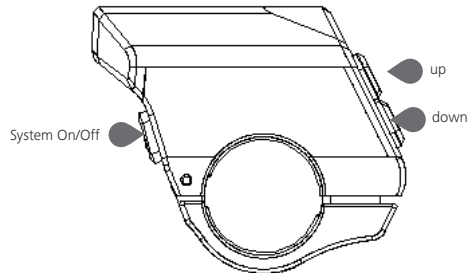
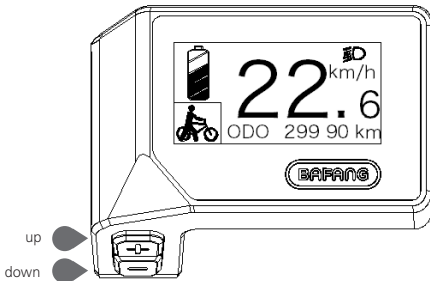

Service: Please see the service section

7.6 KEY DEFINITION



7.7 NORMAL OPERATION



7.7.1 Switching the System ON/OFF

Press and hold  (>2S) on the display to turn on the system. Press and hold  (>2S) again to turn off the system.

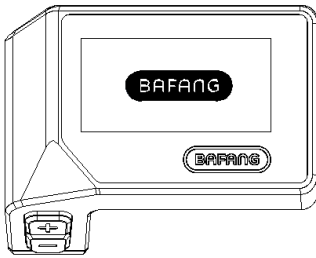
If the "automatic shutdown time" is set to 5 minutes (it can be reset with the "Auto Off" function, See "Auto Off"), the display will automatically be turned off within the desired time when it is not in operation. If the password function is enabled, you must enter the correct password to use the system.



7.7.2 Selection of Support Levels

When the display is turned on, press the  or  button (<0.5S) to switch to the support level, the lowest level is 0, the highest level is 3. When the system is switched on, the support level starts in level 1. There is no support at level 0.

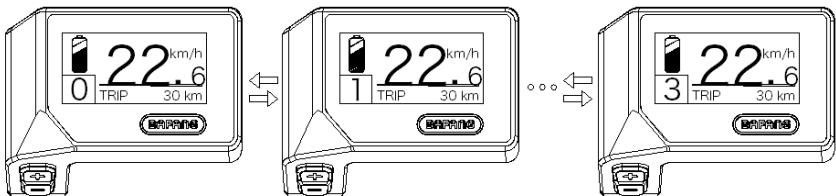

7.7.3 Selection mode

Briefly press the  button (<0.5s) to see the different trip modes.

Trip: daily kilometers (TRIP) - total kilometers (ODO) - Maximum speed (MAX) - Average speed (AVG) - Remaining distance (RANGE) - Energy consumption (CALORIES) - Output power (POWER) - Travel time (TIME).

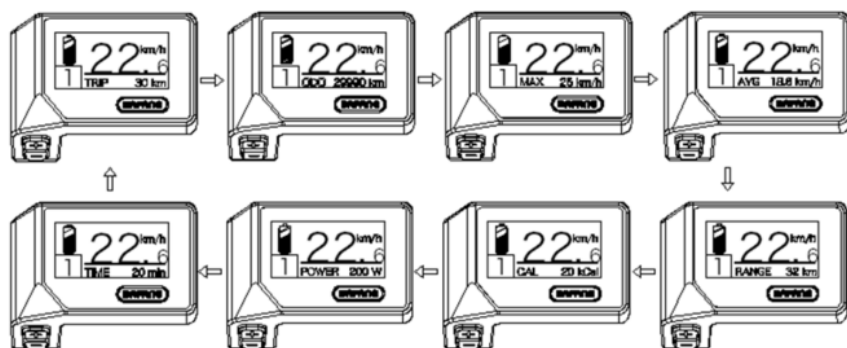

7.7.4 Headlights / backlighting

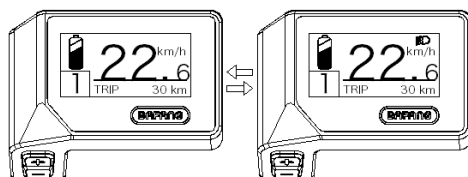

Hold the **+** button (>2S) to activate the headlight and taillights.

Hold the **+** button (>2S) again to turn off the headlight. The brightness of the backlight can be set in the display settings **"Brightness"**.



7.7.5 Walk Assistance

The Walk assistance can only be activated with a standing pedelec.

Activation: Press the **+** button until this symbol  appears. Next press and hold down the **+** button whilst the  symbol is displayed, now the Walk assistance will activate. The symbol  will blink and the pedelec moves approx. 4.5 km/h. After releasing the **+** button or no button is pressed within 5S, the motor stops automatically and switches back to level 0.



7.7.6 SERVICE

The display shows "SERVICE" as soon as a certain number of kilometers or battery charges has been reached. With a mileage of more than 5000 km (or 100 charge cycles), the "SERVICE" function is displayed on the display. Every 5000 km the display "SERVICE" is displayed every time. This function can be set in the display settings.

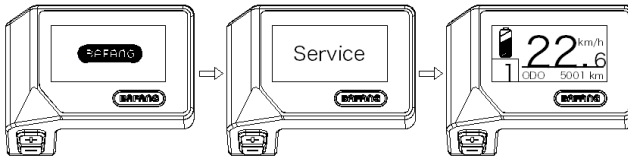

7.7.7 Battery capacity indicator

The battery capacity is shown in the top left of the display. Each full bar represents a remaining capacity of the battery in a percentage.

(as shown in the diagram below):

Capacity Range	Indicator
80%-100%	
60%-80%	
40%-60%	
20%-40%	
5%-20%	
<5%	blinking

7.8 SETTINGS

After the display is turned on, press and hold the **+** and **-** buttons (at the same time) to enter into the setting menu, By pressing the **+** or **-** button (<0.5S), you can highlight and select Display Setting, Information or Exit. Then press the **⏻** button (<0.5S) to confirm your selected option.

Or highlight "EXIT" and press the **⏻** button (<0.5S) to return to the main menu, or highlight "BACK" and press (<0.5S) the **⏻** button (<0.5S) to return to the Settings interface.

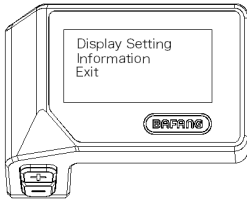

7.8.1 "Display Setting"

Press the **+** or **-** button (<0.5S) and highlight Display Setting, and then briefly press the **⏻** button (<0.5S) to access the following selections.

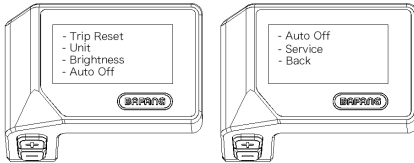

7.8.1.1 "TRIP Reset" Reset mileage

Press the **+** or **-** button (<0.5S) to highlight "Trip Reset" in the Display setting menu, and then press **⏻** button (<0.5S) to select. Then with the **+** or **-** button choose between "YES" or "NO". Once you have chosen your desired selection, press the **⏻** button (<0.5S) to save and exit to the "Display setting".

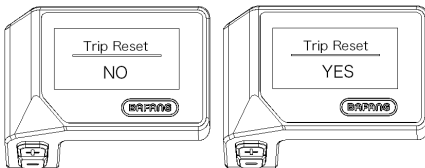

7.8.1.2 "Unit" Selections in km/Miles

Press the **+** or **-** button (<0.5S) to highlight "Unit" in the Display setting menu, and then press **⏻** button (<0.5S) to select. Then with the **+** or **-** button choose between "Metric" (kilometer) or "Imperial" (Miles). Once you have chosen your desired selection, press the **⏻** button (<0.5S) to save and exit to the "Display setting".

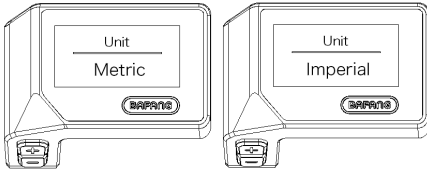

7.8.1.3 "Brightness" Display brightness

Press the **+** or **-** button (<0.5S) to highlight "Brightness" in the Display setting menu, and then press **⏻** button (<0.5S) to select. Then with the **+** or **-** button choose between "100%" / "75%" / "50%" / "30%" / "10%". Once you have chosen your desired selection, press the **⏻** button (<0.5S) to save and exit to the "Display setting".

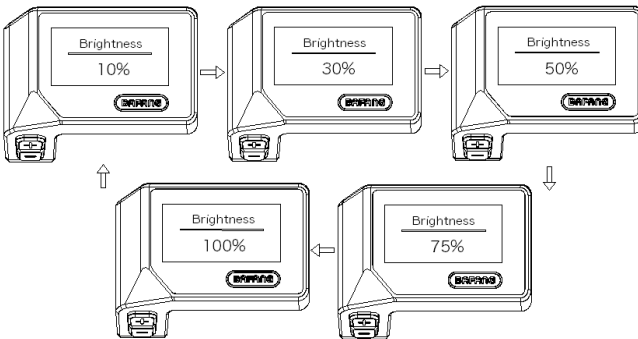

7.8.1.4 "Auto Off" Set Automatic system switch off time

Press the **+** or **-** button (<0.5S) to highlight "Auto Off" in the Display setting menu, and then press **⏻** button (<0.5S) to select. Then with the **+** or **-** button choose between "OFF", "9"/"8"/"7"/"6"/"5"/"4"/"3"/"2"/"1", (The numbers are measured in minutes). Once you have chosen your desired selection, press the **⏻** button (<0.5S) to save and exit to the "Display setting".

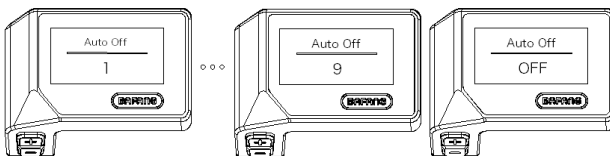

7.8.1.5 "Service" Switching the notification on and off

Press the **+** or **-** button (<0.5S) to highlight "Service" in the Display setting menu, and then press **⏻** button (<0.5S) to select. Then with the **+** or **-** button choose between "NO" or "YES". Once you have chosen your desired selection, press the **⏻** button (<0.5S) to save and exit to the "Display setting".

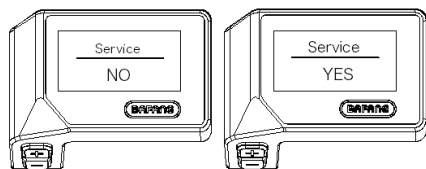

7.8.2 "Information"

Once the display is turned on, press and hold the **+** and **-** buttons (at the same time) to enter into the setting menu, press the **+** or **-** button (<0.5S) to select "Information", then press the **⏻** button (<0.5S) to confirm and enter into "Information".

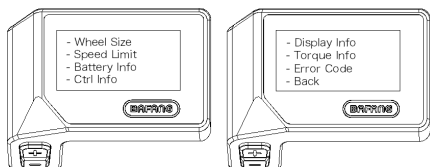

7.8.2.1 Wheel Size

Press the **+** or **-** button (<0.5S) to highlight "Wheel Size", then press the **⏻** button (<0.5S) to confirm and view the wheel size. To return, press the **⏻** button (<0.5S) to exit back to the "Information".

This information cannot be changed, this is only for information, about the pedelec.



7.8.2.2 Speed Limit

Press the **+** or **-** button (<0.5S) to highlight "Speed Limit", then press the **⏻** button (<0.5S) to confirm and view the speed limit. To return, press the **⏻** button (<0.5S) to exit back to the "Information".

This information cannot be changed, this is only for information, about the pedelec.

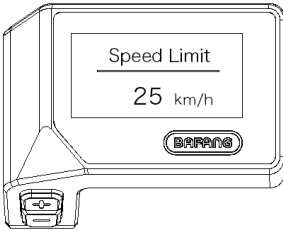

7.8.2.3 Battery Information

Press the **+** or **-** button (<0.5S) to highlight "Battery Info", then press the **⏻** button (<0.5S) to confirm. Now press the **+** or **-** button (<0.5S) to view the contents.

To return, press the **⏻** button (<0.5S) to exit back to the "Information".

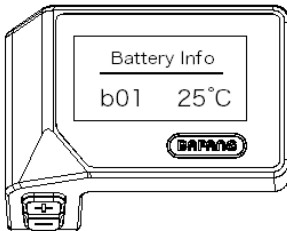

Code	Code definition	unit	Code	Code definition	unit
Hardware ver	Hardware version		b10	Absolute SOC	%
Software ver	Software version		b11	Cycle	times
b01	Current temperature	°C	b12	Maximum not charging time	Hour
b04	Total voltage	mV	b13	Recently not charging time	Hour
b06	Average current	mA	d00	Number of battery cell	
b07	Remaining capacity	mAh	d01	Voltage of cell 1	mV
b08	Full charge capacity	mAh	d02	Voltage of cell 2	mV
b09	Relative SOC	%	dn	Voltage of cell n	mV

NOTE: If no data is detected, "--" is displayed.

7.8.2.4 Controller Information

Press the **+** or **-** button (<0.5S) to highlight "Ctrl Info", then press the **⏻** button (<0.5S) to confirm. Now press the **+** or **-** button (<0.5S) to view Hardware Version or Software Version.

To return, press the **⏻** button (<0.5S) to exit back to the "Information".

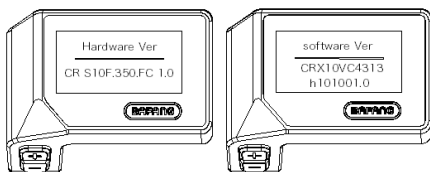

7.8.2.5 Display Information

Press the **+** or **-** button (<0.5S) to highlight "Display Info", then press the **⏻** button (<0.5S) to confirm. Now press the **+** or **-** button (<0.5S) to view Hardware Version or Software Version.

To return, press the **⏻** button (<0.5S) to exit back to the "Information".

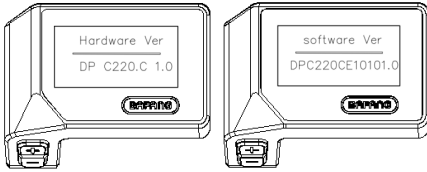

7.8.2.6 Torque Information

Press the **+** or **-** button (<0.5S) to highlight "Torque Info", then press the **⏻** button (<0.5S) to confirm. Now press the **+** or **-** button (<0.5S) to view Hardware Version or Software Version.

To return, press the **⏻** button (<0.5S) to exit back to the "Information".

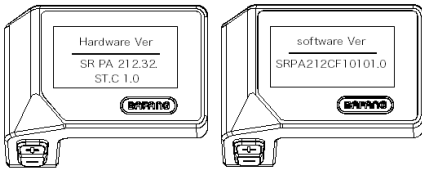

7.8.2.7 Error Code

Press the **+** or **-** button (<0.5S) to highlight "Error code", then press the **⏻** button (<0.5S) to confirm. Now press the **+** or **-** button (<0.5S) to view a list of error codes from the pedelec. It can show information for the last ten errors of the pedelec. The error code "00" means that there is no error.

To return, press the **⏻** button (<0.5S) to exit back to the "Information".

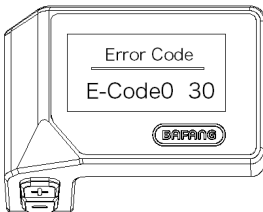

7.9 ERROR CODE DEFINITION

 The HMI can show the faults of Pedelec. When a fault is detected, one of the following error codes will be indicated too.

Note: Please read carefully the description of the error code. When the error code appears, please first restart the system. If the problem is not eliminated, please contact your dealer or technical personnel.

Error	Declaration	Troubleshooting
04	The throttle has fault.	<ol style="list-style-type: none"> 1. Check the connector and cable of the throttle are not damaged and correctly connected. 2. Disconnect and reconnect the throttle, if still no function please change the throttle.
05	The throttle is not back in its correct position.	Check the connector from the throttle is correctly connected. If this does not solve the problem, please change the throttle.
07	Overvoltage protection	<ol style="list-style-type: none"> 1. Remove and re-Insert the battery to see if it resolves the problem. 2. Using the BESST tool update the controller. 3. Change the battery to resolve the problem.
08	Error with the hall sensor signal inside the motor	<ol style="list-style-type: none"> 1. Check all connectors from the motor are correctly connected. 2. If the problem still occurs, please change the motor.
09	Error with the Engine phase's	Please change the motor.
10	The temperature inside the engine has reached its maximum protection value	<ol style="list-style-type: none"> 1. Turn off the system and allow the Pedelec to cool down. 2. If the problem still occurs, please change the motor.
11	The temperature sensor inside the motor has an error	Please change the motor.
12	Error with the current sensor in the controller	Please change the controller or contact your supplier.

Error	Declaration	Troubleshooting
13	Error with the temperature sensor inside of the battery	<ol style="list-style-type: none"> 1. Check all connectors from the battery are correctly connected to the motor. 2. If the problem still occurs, please change the Battery.
14	The protection temperature inside the controller has reached its maximum protection value	<ol style="list-style-type: none"> 1. Allow the pedelec to cool down and restart the system. 2. If the problem still occurs, please change the controller or contact your supplier.
15	Error with the temperature sensor inside the controller	<ol style="list-style-type: none"> 1. Allow the pedelec to cool down and restart the system. 2. If the problem still occurs, Please change the controller or contact your supplier.
21	Speed sensor Error	<ol style="list-style-type: none"> 1. Restart the system 2. Check that the magnet attached to the spoke is aligned with the speed sensor and that the distance is between 10 mm and 20 mm. 3. Check that the speed sensor connector is connected correctly. 4. Connect the pedelec to BESST, to see if there is a signal from the speed sensor. 5. Using the BESST Tool- update the controller to see if it resolves the problem. 6. Change the speed sensor to see if this eliminates the problem. If the problem still occurs, please change the controller or contact your supplier.
25	Torque signal Error	<ol style="list-style-type: none"> 1. Check that all connections are connected correctly. 2. Please connect the pedelec to the BESST system to see if torque can be read by the BESST tool. 3. Using the BESST Tool update the controller to see if it resolves the problem, if not please change the torque sensor or contact your supplier.

Error	Declaration	Troubleshooting
26	Speed signal of the torque sensor has an error	<ol style="list-style-type: none"> 1. Check that all connections are connected correctly. 2. Please connect the pedelec to the BESST system to see if speed signal can be read by the BESST tool. 3. Change the Display to see if the problem is solved. 4. Using the BESST Tool update the controller to see if it resolves the problem, if not please change the torque sensor or contact your supplier.
27	Overcurrent from controller	Using the BESST tool update the controller. If the problem still occurs, please change the controller or contact your supplier.
30	Communication problem	<ol style="list-style-type: none"> 1. Check all connections on the pedelec are correctly connected. 2. Using the BESST Tool run a diagnostics test, to see if it can pinpoint the problem. 3. Change the display to see if the problem is solved. 4. Change the EB-BUS cable to see if it resolves the problem. 5. Using the BESST tool, re-update the controller software. If the problem still occurs please change the controller or contact your supplier.
33	Brake signal has an error (If brake sensors are fitted)	<ol style="list-style-type: none"> 1. Check all connectors are correctly connected on the brakes. 2. Change the brakes to see if the problem is solved. <p>If problem continues Please change the controller or contact your supplier.</p>
35	Detection circuit for 15V has an error	Using the BESST tool update the controller to see if this resolves the problem. If not, please change the controller or contact your supplier.
36	Detection circuit on the keypad has an error	Using the BESST tool update the controller to see if this resolves the problem. If not, please change the controller or contact your supplier.

Error	Declaration	Troubleshooting
37	WDT circuit is faulty	Using the BESST tool update the controller to see if this resolves the problem. If not, please change the controller or contact your supplier.
41	Total voltage from the battery is too high	Please change the battery.
42	Total voltage from the battery is too low	Please Charge the battery. If the problem still occurs, please change the battery.
43	Total power from the battery cells is too high	Please change the battery.
44	Voltage of the single cell is too high	Please change the battery.
45	Temperature from the battery is too high	Please let the pedelec cool down. If problem still occurs, please change the battery.
46	The temperature of the battery is too low	Please bring the battery to room temperature. If the problem still occurs, please change the battery.
47	SOC of the battery is too high	Please change the battery.
48	SOC of the battery is too low	Please change the battery.
61	Switching detection defect	1. Check the gear shifter is not jammed. 2. Please change the gear shifter.
62	Electronic derailleur cannot release.	Please change the derailleur.
71	Electronic lock is jammed	1. Using the BESST tool update the Display to see if it resolves the problem. 2. Change the display if the problem still occurs, please change the electronic lock.
81	Bluetooth module has an error	Using the BESST tool, re-update the software onto the display to see if it resolves the problem. If not, Please change the display.